

EF TAPPING SADDLE

04 Update - 05/2024

TECHNICAL DATA

Article No	001 117 2071 0147
d (mm)	140
d1 (mm)	40
le (mm)	85
h (mm)	238
h1 (mm)	95
Z (mm)	150
L (mm)	140
Weight (Kg)	0,900
Box Quantity (pcs)	6
Box Dimension (cm)	55x30x37,5

INJECTION MOULDED

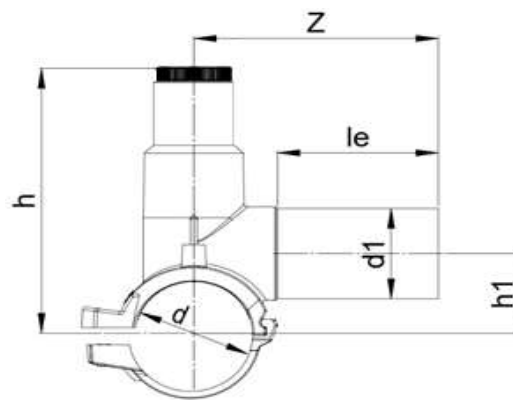

IDENTIFICATION OF PRODUCT

D(mm)	140-40
SDR	11
RAW MATERIAL	PE 100
PRESSURE CLASS	16 Bar Water 10 Bar Gas
TRADEMARK	NTG
EXECUTION	Injection Moulded
STANDARD	EN 12201-3 EN 1555-3 AS / NZS 4129

SPECIFICATION	Suitable for SDR11....17 pipe Injected monobloc type 4 mm pin connectors Long Fusion outlet Hexagon wrench 12 mm O-ring sealed screw cap
---------------	---

EF SPECIFICATION

WELDING VOLTAGE	40 V
RESISTANCE	7,0 Ω
WELDING TIME	130 Sec.
COOLING TIME	15 Min.
WINDING TYPE	Monofilar
WELDING BARCODE	



Tolerance on diameters and thickness according to the standards. The other dimensions are specialized. Tolerance $\pm 5\%$. NTG PLASTIK reserves all the right to change any information without giving prior notice. The production, distribution and utilization of this document without explicit authorization is prohibited.